

CARTRIDGE HEATERS

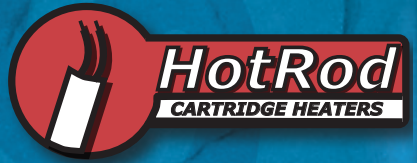

MARATHON HEATER



Same day shipment on 1000's of models!



RoHS
COMPLIANT 



Made in USA



INDEX

- CONSTRUCTION.....3
- STANDARD SPECIFICATIONS.....3
- WATT DENSITY.....4
- SHEATH OPTIONS.....4
- LEAD WIRE OPTIONS.....4
- TERMINATION OPTIONS.....5
- END SEALS.....9
- CUSTOM FITTINGS.....10
- FITTING OPTIONS.....10
- FLANGES.....11
- MECHANICAL STOPS.....11
- THERMOCOUPLES.....11
- LENGTH CONTROL.....12
- CONSTRUCTION OPTIONS.....12
- CIRCUIT OPTIONS.....14
- TODAY HEATERS.....15
- NON-SWAGED CARTRIDGE HEATERS.....16
- SQUARE CARTRIDGE HEATERS.....17
- ENGINEERING DATA.....18
- ORDERING.....19
- FREQUENTLY ASKED QUESTIONS.....19

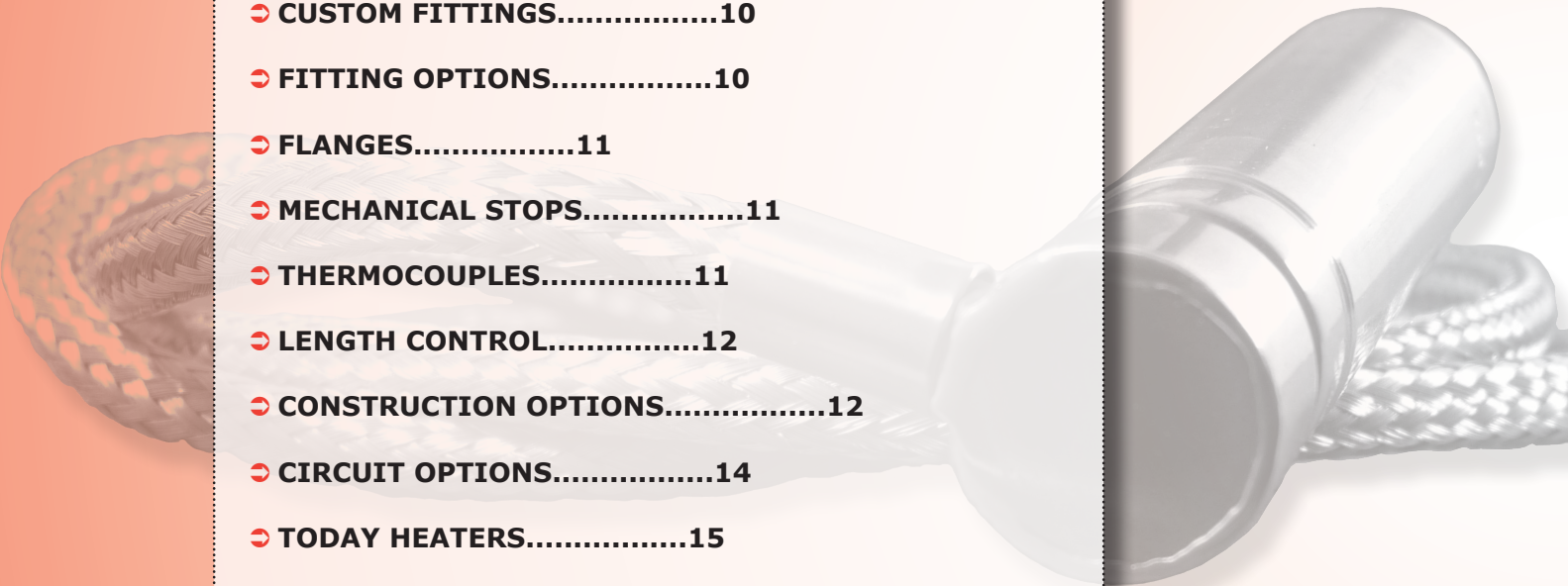

UL File No: E202904
CSA File No: LR 109455-1
RoHS Compliant

- Questions?
- Phone: (830)-775-1417
- Fax: (830)-775-4379
- Email: sales@marathonheater.com
- <http://www.marathonheater.com>

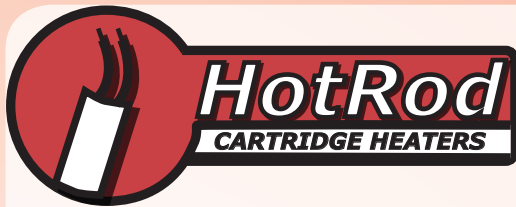

The engineers at Marathon Heater have developed a cartridge heater that exceeds the performance and durability of other cartridge heaters. Through refinements in the swaging process, specially designed cores, careful selection of magnesium oxide fill, nickel chromium resistance wire, stainless steel tubing, and carefully controlled production processes, HotRods routinely outperform other cartridge heaters in difficult applications.

HotRods are available in a wide variety of diameters and configurations. Choose from our 14,000+ stock heaters for immediate delivery or let the engineers at Marathon Heater design a unique heater for your special application. Standard manufacturing times are normally less than 2 weeks.

CONSTRUCTION

- 1. High Temperature Lead Wires** for temperatures up to 550° C.
- 2. High Impact Ceramic Cap** retards contamination and is suitable for high vibration applications. Deep holes in cap prevent fraying of leads when bent.
- 3. Nickel-Chromium Resistance Wire** for maximum heater life, evenly wound for even heat distribution.
- 4. High Purity Magnesium Oxide** fill selected for maximum dielectric strength and thermal conductivity, highly compacted for maximum heat transfer.

5. 304 Stainless Steel Sheath for oxidation resistance in a wide variety of environments. 316 Stainless Steel and Incoloy® are also available. Please consult the application guide in the back for help in determining which material is best for your application.

6. TIG Welded End Disc to prevent contamination and moisture absorption.

HotRods are UL recognized, File #E202904, CSA certified, CSA file no. LR 109455-1 and RoHS Compliant.

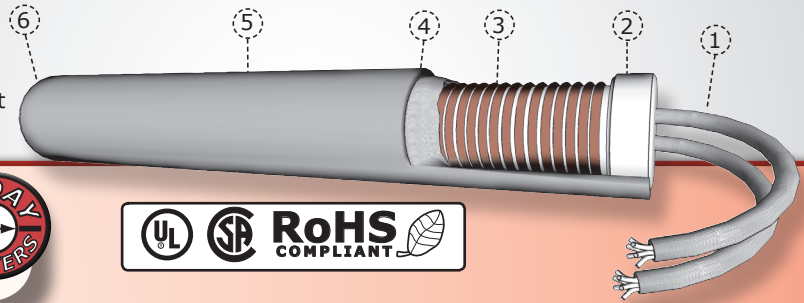

Select stock heaters may be customized according to your needs **and still be shipped the same day!!**



Ask for our TODAY Heaters line **TODAY!**

STANDARD SPECIFICATIONS

Nominal Diameter	Minimum Diameter	Maximum Diameter	Std. Lead Wire Gauge	Max amps with Std. Lead wire	Max lead wire gauge	Maximum Amps	Maximum Volts
1/8"	.12	.12	24	3.6	24	3.6	300
1/4"	.24	.25	24	6	22	9	300
6.5 mm	.25	.25	24	6	22	9	300
5/16"	.37	.31	24	6	22	9	480
8 mm	.31	.31	24	6	22	9	480
3/8"	.37	.37	22	9	18	15	480
10 mm	.39	.39	22	9	18	15	480
12 mm	.47	.47	22	9	18	15	480
12.5 mm	.49	.49	22	9	18	15	480
1/2"	.50	.50	22	9	18	15	480
13 mm	.51	.51	22	9	18	15	480
17/32	.52	.53	22	9	18	15	480
14 mm	.54	.55	18	15	14	26	480
5/8"	.62	.62	18	15	14	26	480
16 mm	.62	.63	18	15	14	26	480
17 mm	.66	.67	18	15	14	26	480
11/16"	.68	.69	18	15	14	26	480
19 mm	.74	.75	18	15	14	26	480
3/4"	.74	.75	18	15	14	26	480
25 mm	.98	.98	18	15	14	26	480
1"	.99	1.0	18	15	14	26	480

- Length tolerance is $\pm 3/32$ or $\pm 3\%$ whichever is greater. For more on this, see "LENGTH CONTROL" on page 12.
- Camber tolerance is .025 per foot of length. Slight camber is normally not a problem since the heater will flex enough to enter a clean hole
- Wattage tolerance is +5%, -10%.

SPECIFICATIONS

WATT DENSITY

- The tighter the hole fit, the better. Loose fit equals poor heat transfer and shorter heater life.
- Clearance is determined by taking the hole diameter and subtracting the heater diameter.
- Cycling reduces heater life and high cycling applications should use lower numbers.
- Please consult the following tables for the maximum allowable watt density for heating metals.

FORMULA

Watt density is calculated with the following formula:

$$\text{Watt Density} = \frac{\text{Wattage}}{\text{Heated Length} \times \text{Diameter} \times 3.14}$$

MAXIMUM WATT DENSITY FOR HEATING METALS

Hole Clearance	Block Temperature in °F					
	1200	1000	800	600	400	200
0.00	140	270	300	300	300	300
0.00	120	205	295	300	300	300
0.00	100	175	240	300	300	300
0.00	90	145	200	285	300	300
0.01	70	100	150	200	250	300
0.01	60	90	110	150	200	225
0.01	50	75	95	110	140	165
0.03	40	60	80	90	100	110
0.06	30	40	50	55	65	65
0.10	25	35	45	50	50	50

SHEATH OPTIONS

- Incoloy: For applications to 1600°F
- 304 Stainless Steel: For applications to 1400 °F
- 316 Stainless Steel: For corrosive environments
- For more information, see sheath suitability chart on page 18.

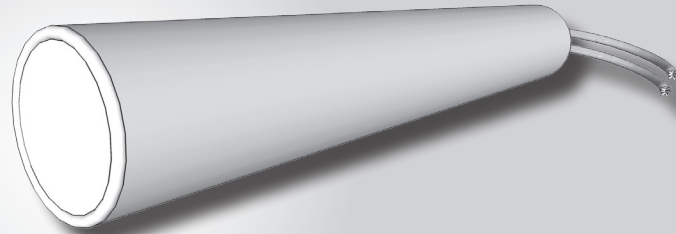

LEAD WIRE OPTIONS

Wire type	Maximum Recommended Temperature	Comments
Duraflex	550°C	Highest temperature rating, durable, non-fraying, good moisture resistance. This is our standard lead wire.
Teflon	250°C	Good dielectric strength.
Silicon Rubber	200°C	Good moisture resistance.
Braided Silicon Rubber	200°C	Inexpensive wire, good for non-abrasive applications.
SJO Cord	90°C	Rubber jacket, resistant to oil and moisture. For use on 3/8" diameter and larger.

TERMINATION OPTIONS

SWAGED IN LEADS

- Swaged in leads are ideal for applications where there is a lot of movement or the leads must be bent sharply upon exiting the heater.
- Please note that for heaters over 3" long there is a short unheated section where the leads connect to the power pins.
- Also remember that if the heater is inserted completely into the hole, the leads are exposed to the block temperature (maximum temperature for standard leads is 550°C , 1022°F.).
- Unless otherwise specified, all heaters are supplied with swaged in leads.

Unheated Length



Unheated Length at Lead End of Heater

Heater Length	Heater Diameter (inches)						
	1/4"	5/16"	3/8"	1/2"	5/8"	3/4"	1"
Under 3" long	.20	.20	.25	.30	.39	.39	.61
Over 3" long	.81	.79	.84	.84	1.01	1.00	1.27

CRIMPED ON LEADS

- Crimped on leads are generally used where the temperature at the end of the heater exceeds the maximum rated temperature of the lead wire. Since the connection between the leads and power pins is made outside the heater, the unheated length at the lead end of the heater is kept to a minimum.
- Crimped on leads are not recommended for applications where the leads must be bent sharply near the heater, or in applications where the leads will be subject to a lot of flexing.
- The high temperature connectors are covered by 1-1/2" of 2500 volt silicone rubber coated fiberglass sleeving.

Unheated Length



Unheated Length at Lead End of Heater

Heater Length	Heater Diameter (inches)						
	1/4"	5/16"	3/8"	1/2"	5/8"	3/4"	1"
Under 3" long	.20	.20	.25	.29	.54	.54	.74
Over 3" long	.20	.20	.25	.29	.54	.54	.81

RIGHT ANGLE LEADS

- Right angle leads are ideal for applications where space is limited.
- Leads are covered with a silicon impregnated fiberglass sleeve where they exit the heater.
- When ordering, please specify the overall length.

Unheated Length

Extension Length

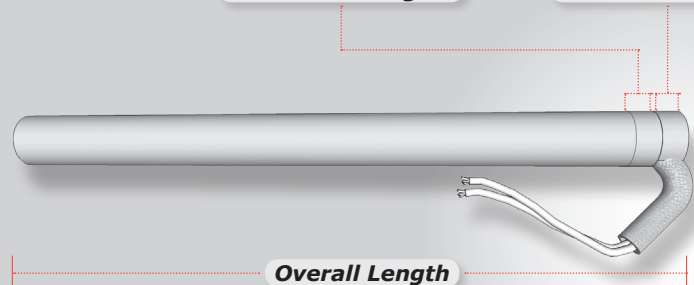

Overall Length

Unheated Length at Lead End of Heater

Heater Length	Heater Diameter (inches)						
	1/4"	5/16"	3/8"	1/2"	5/8"	3/4"	1"
Under 3" long	.20	.20	.25	.29	.39	.39	.24
Over 3" long	.81	.79	.84	.84	1.01	1.00	.31
Extension length	.25	.25	.31	.37	.37	.37	.75

TERMINATION OPTIONS

STRAIGHT BRAID

- Swaged in stainless steel braid provides excellent abrasion protection while allowing the leads to be bent in a tight radius.
- Because the braid is swaged in, it is extremely resistant to pulling out of the heater.

Unheated Length

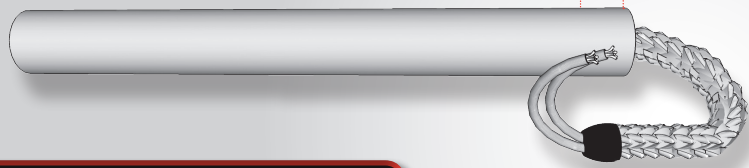

Unheated Length at Lead End of Heater

Heater Diameter (inches)

Heater Length	1/4"	5/16"	3/8"	1/2"	5/8"	3/4"	1"
Under 3" long	.25	.20	.35	.29	.39	.39	.54
Over 3" long	.86	.79	.94	.84	1.01	1.00	1.20

RIGHT ANGLE BRAID

- Right angle stainless steel braid offers the same advantages as straight swaged in stainless steel braid but allows use in tight spaces.
- When ordering, please specify the overall length.

Unheated Length Extension Length



Unheated Length at Lead End of Heater

Heater Diameter (inches)

Heater Length	1/4"	5/16"	3/8"	1/2"	5/8"	3/4"	1"
Under 3" long	.20	.20	.25	.29	.39	.39	.24
Over 3" long	.81	.79	.84	.84	1.01	1.00	.31
Extension Length	.31	.31	.37	.37	.44	.44	.75

STAINLESS STEEL FLEXIBLE CONDUIT

- Flexible conduit provides maximum lead protection from abrasion but can not be bent as sharply as stainless steel braid.
- Flexible conduit is swaged into the heater for maximum protection. (Flexible conduit is also known as armor or hose).

Unheated Length



Unheated Length at Lead End of Heater

Heater Diameter (inches)

Heater Length	1/4"	5/16"	3/8"	1/2"	5/8"	3/4"	1"
Under 3" long	.62	.60	.30	.23	.39	.39	.54
Over 3" long	1.23	1.20	.89	.84	1.01	1.00	1.20
Conduit O. D.	.25	.303	1.4"	.303	.37	.48	.48

TERMINATION OPTIONS

RIGHT ANGLE STAINLESS STEEL FLEXIBLE CONDUIT

- Right angle stainless steel conduit offers the same advantages as swaged in stainless steel conduit but allows use in tight spaces.
- When ordering, please specify the overall length.

Unheated Length Extension Length

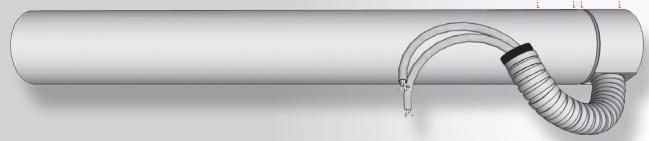

Unheated Length at Lead End of Heater

	Heater Diameter (inches)						
Heater Length	1/4"	5/16"	3/8"	1/2"	5/8"	3/4"	1"
Under 3" long	.55	.60	.65	.70	.90	.80	.24
Over 3" long	.81	.79	.84	.84	1.01	1.00	.31
Extension Length	.31	.37	.37	.37	.44	.44	.75
Conduit O. D.	.25	.25	.33	.37	.37	.37	.37

CONVOLUTED CONDUIT

- It is not a seal at all, but rather a sealed, stainless steel, flexible hose brazed to the heating element.
- This protects the leads and covers the end of the heater. It is rated for applications up to 1100° F.
- While the hose is flexible, it is not recommended for applications with continuous flexing and movement.
- It is available only on heaters 1/2" diameter and larger.



Specifications

	O. D.	I. D.	Dynamic Bend Radius	Static Bend Radius
Specifications	.50"	.25"	5"	1"

RIGHT ANGLE COPPER ELBOW WITH CONDUIT

- Right angle flexible conduit can also be attached to the sheath with a copper elbow.
- This method can also be used to attach right angle flexible conduit to stock heaters.
- Order length = Insertion Length + "A" Dimension

Order Length = Insertion Length + "A" Length

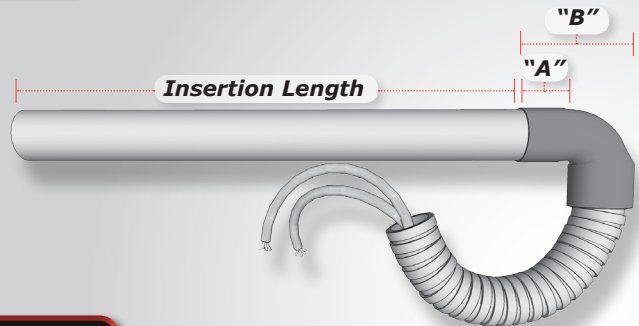

Heater Diameter

	.25"	.37"	.50"	.62"	.75"
"A" Dimension	.29	.38"	.48	.57	.75
"B" Dimension	.85	.91	1.16	1.25	1.90
Conduit O.D.	.25	.37	.48	.625	.62

TERMINATION OPTIONS

COPPER COUPLER

- Flexible conduit can also be attached to the sheath with a copper coupler.
- This method can also be used to attach flexible conduit to stock heaters.

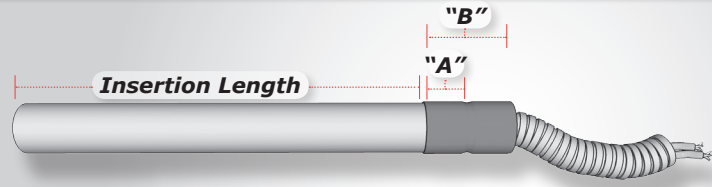

Order Length = Insertion Length + "A" Length

Heater Diameter

	.25"	.37"	.50"	.62"	.75"
"A" Dimension	.29	.38	.48	.57	.75
"B" Dimension	.70	.70	.85	1.10	1.35
Conduit O.D.	.25	.37	.48	.62	.62

CERAMIC BEADS

- When the temperature at the exit area of the heater is higher than 1100°F, ceramic beads protect the wires until conventional insulation can be utilized.

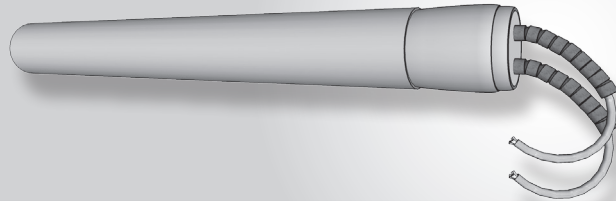

STRAIGHT PINS

- Conductor pins bonded to resistance wire.
- Uses minimum unheated length at end of heater.

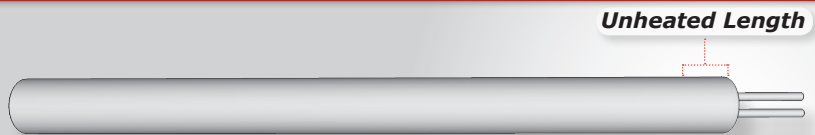

Unheated Length at Lead End of Heater

	Heater Diameter (inches)						
Heater Length	1/4"	5/16"	3/8"	1/2"	5/8"	3/4"	1"
Under 3" long	.20	.20	.25	.29	.54	.54	.74
Over 3" long	.20	.20	.25	.29	.54	.54	.81

TERMINATION OPTIONS

SLEEVING

Type	Max Rec.	Comments
Silicone Rubber Fiberglass Sleeving	200 °C	Can sleeve both leads together or each lead separately.
Fiberglass Sleeving	240 °C	Good for lead protection and used over crimps.

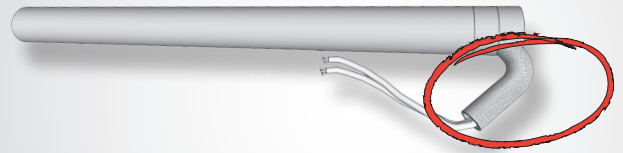

END SEALS

LAVA SEAL

- A swaged in lava plug protects the internal cartridge from contamination.
- Up to 1500 °F

CEMENT

- Provides protection against some thicker liquids and dust, however it is not waterproof. It is also somewhat brittle and subject to cracking in high impact or high vibration applications.
- Up to 2600 °F.

TEFLON® SEAL

- Teflon Seals are a mechanical seal constructed by compressing a solid piece of Teflon in the end of the heater creating a seal between the Teflon piece and sheath, and a seal between the Teflon piece and the lead wire.
- An unheated section of 1" at the end of the heater is generally required to avoid overheating the seal.
- Teflon lead wire is used in conjunction with the Teflon end seal. While Teflon seal has a temperature rating of 350 °F, it softens slightly above 300 °F and can relax and compromise the seal.

EPOXYLITE® POTTING

- Provides similar mechanical properties as epoxy potting.
- Up to 600 °F.

EPOXY POTTING

- Provides a very good seal with excellent mechanical strength. However, it's adherence to Teflon or silicone rubber lead wire is only fair.
- Up to 265 °F, and bonds well to Duraflex lead wire.

RTV

- Provides a good moisture seal.
- Up to 500 °F.
- Works well with silicone rubber leads (silicone rubber leads rated to 392 °F.).

COMPARE!

End Seals and Lead Wires

Type	Temperature	Moisture Applications	Vibration or Flexing
Cement	2600 °F	Poor	Poor
Lava Seal	1500 °F	Poor	Poor
EpoxyLite	600 °F	Good	Excellent
Teflon Seal	350 °F	Good	Excellent
RTV w/ Silicone Rubber Leads	392 °F	Excellent	Average
Epoxy	265 °F	Good	Good

FITTING OPTIONS

SINGLE ENDED NPT FITTINGS

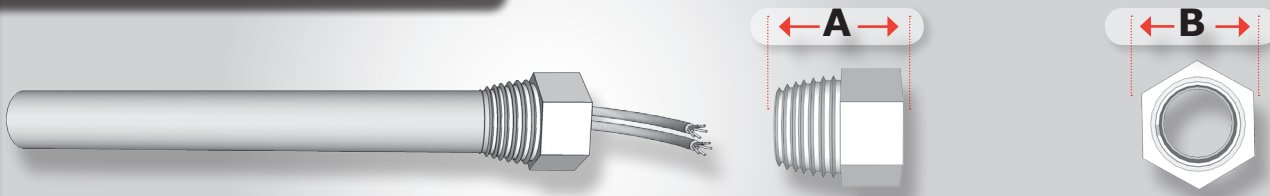

SPECIFICATION CHART

Heater Diameter	1/4"	3/8"	1/2"	5/8"	3/4"	1"
NPT Thread Size	1/8	1/4	3/8	1/2	3/4	1
Brass "A"	.57	.70	.74	.80	.92	1.30
Brass "B"	.43	.56	.69	.87	1.06	1.44
Stainless Steel "A"	.62	.76	.77	.84	.96	1.27
Stainless Steel "B"	.46	.56	.67	.87	1.06	1.37

DOUBLE ENDED NPT FITTINGS

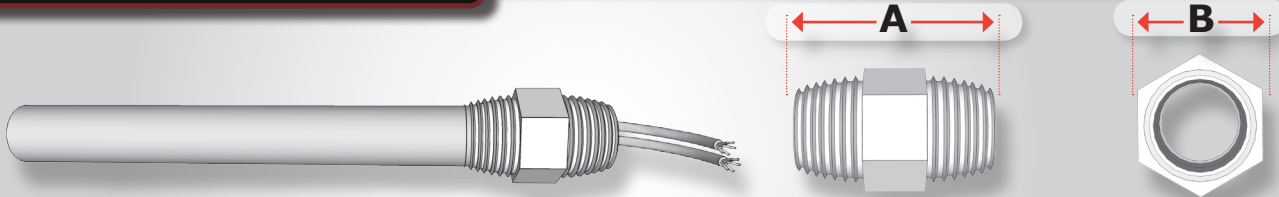

SPECIFICATION CHART

Heater Diameter	1/4"	3/8"	1/2"	5/8"	3/4"	1"
NPT Thread Size	1/8	1/4	3/8	1/2	3/4	1
Brass "A"	.98	1.13	1.25	1.53	1.72	2.35
Brass "B"	.43	.56	.69	.87	1.06	1.37
Stainless Steel "A"	.98	1.13	1.25	1.53	1.72	CALL
Stainless Steel "B"	.43	.56	.68	.87	1.06	CALL

CUSTOM FITTINGS

- Straight Threads
- Brass Cubes
- Stainless Steel Cubes
- Others to Your Specifications

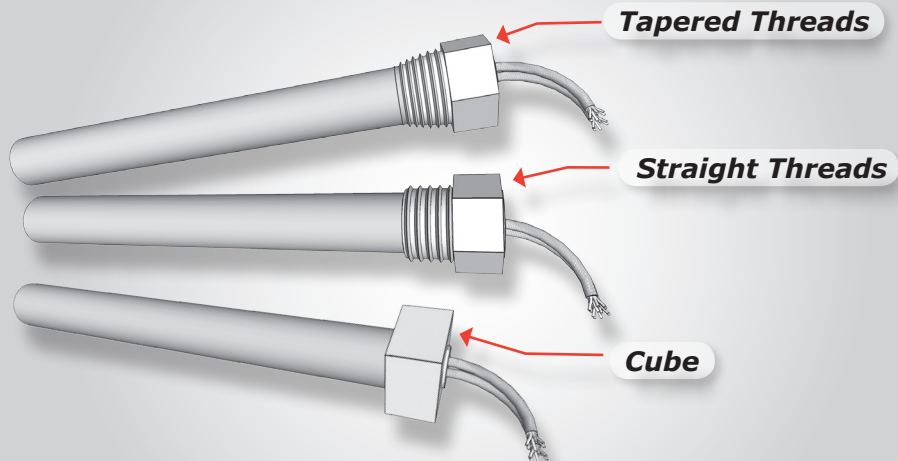

OTHER OPTIONS

INTERNAL THERMOCOUPLE

- Built-in thermocouples can be of type "J" or type "K", grounded or ungrounded, and attached either at the disc end or middle of the cartridge.
- Thermocouple lead wire is 24 ga. solid and, unless otherwise specified, thermocouple leads are the same length as the power leads.
- When ordering, please specify type, location, grounded or ungrounded (if not specified, you will receive grounded), and insulation material (if not specified, you will receive fiberglass).

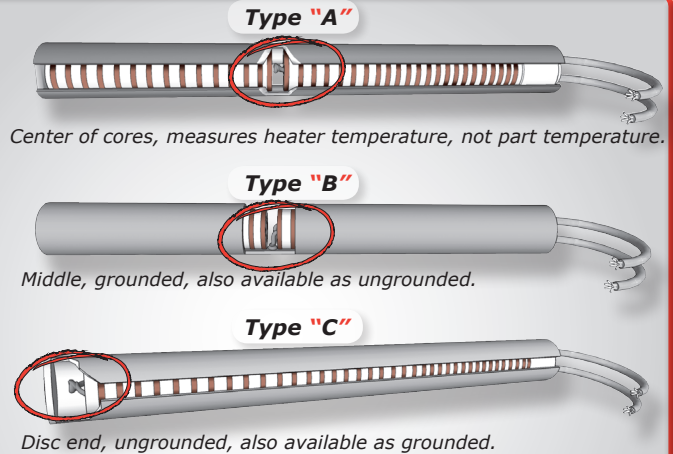

* Sheath has been cut to show the thermocouple.

FLANGES

- Flanges can be welded on the lead end of the heater.
- Flanges can be used to hold a heater in place to prevent backing out during operation.
- Flanges also assist in heater removal.
- Flanges are 1/16" thick

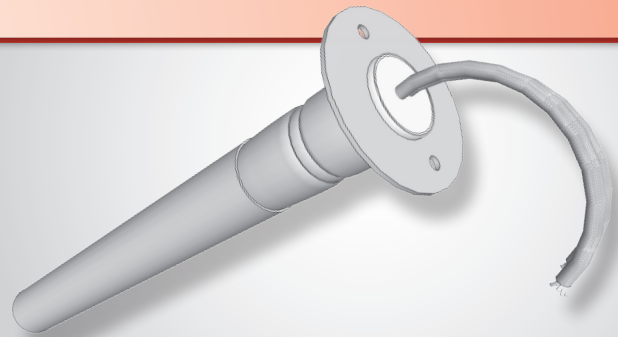

Flange Outside Diameter

	1"	1-1/2"	2"
Can be used on	1/4, 5/16, 3/8, 1/2	1/4, 5/16, 3/8, 1/2, 5/8, 3/4	1/2, 5/8, 3/4, 1
Hole Spacing	3/4	1-1/8	1-1/2
Hole Size	.14	.16	.20

MECHANICAL STOPS

- Weld Beads
- Tab Stops
- Custom Round Flanges
- Custom Rectangular Flanges
- Ideal for preventing heaters from sliding too far into the hole

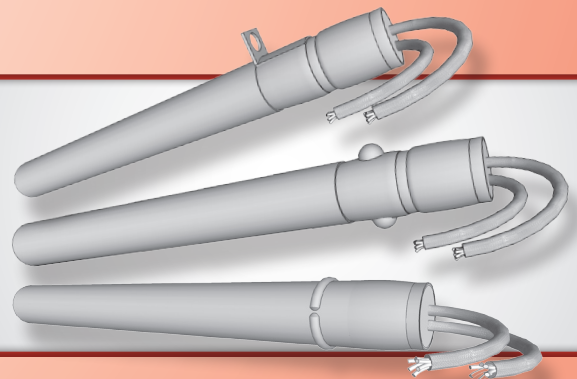

CONSTRUCTION OPTIONS

LENGTH CONTROL

- Due to the large reduction in diameter during the swaging process, cartridge heaters also grow in length. Although the length change is fairly predictable, it is influenced by many factors and yields a larger length tolerance than is found in other manufacturing techniques. When dealing with longer heaters this length variation can be an issue in some applications. There are several alternatives in these situations.
- The simplest is to just order the heater short enough that when at the maximum length tolerance it does not extend beyond the block it has been inserted into. The downside to this is that when the heater is at the short end of the length tolerance, you have empty space in the hole.
- An alternative is to have the heater trimmed to length after the swaging process. As only the unheated portion of the heater can be trimmed away, a large unheated section must be designed into the heater for trimming as illustrated below. The end result is the same amount of unheated block as you would have with the standard heater described above.
- Marathon does offer a heater called the HTS heater which allows for length adjustments in the heated area and produces an exact length heater with minimal unheated section. Unfortunately, this is only an option for some combinations of voltage, wattage, and heated length. Please consult with the engineering department at Marathon Heater to see if this is an option for your application.
- Another good option when watt densities and temperatures permit is a non-swaged heater. Non-swaged heaters are built with a standard length tolerance of $\frac{1}{8}$ ".

FLANGE EXAMPLE

When ordering a heater with 30" below the flange, the heater must be designed so that if they run on the short side of the tolerance. They are still long enough to have 30" below the flange (heater needs to be 30.06 long). This means that the heater has to be designed at 30.99" long and the heaters at the high side of the tolerance could be as long as 31.92" long.

Heater size at **Minimum** Length tolerance.
30.06"

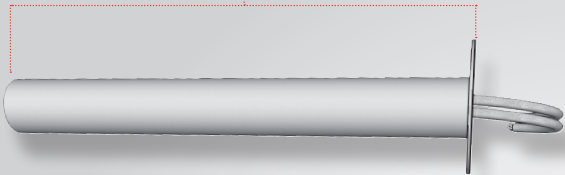

Heater size at **Medium** Length tolerance.
30.99"

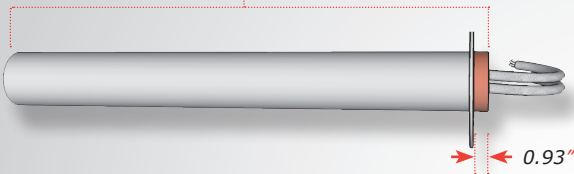

Heater size at **Maximum** Length tolerance.
31.92"

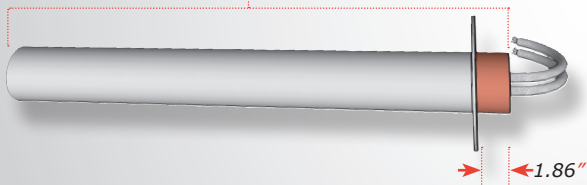

NO FLANGE EXAMPLE

When ordering a heater trimmed to exactly 30", we can not trim away the heated portion of the heater, so we leave a cavity to trim and fill the remaining portion of the cavity with cement. We need to have at least $\frac{1}{8}$ " cavity to pot. So, we require a cavity length that, when we trim the longest heater, will leave us $\frac{1}{8}$ " of cavity. The heaters have to be designed so that the shortest heater is at least 30" long. That means they are designed at 30.92" and the longest one could be 31.98".

• Cavity is $(31.86 - 30) + \frac{1}{8} = 1.98"$

Heater size at **Minimum** Length Tolerance (**no** excess cavity to trim).
30.00"

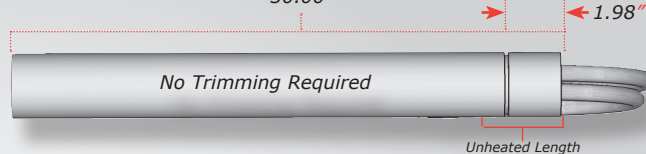

Heater size at **Medium** Length Tolerance (**some** cavity must be trimmed).
30.92"



Heater size at **Maximum** Length Tolerance (**ALL** cavity must be trimmed).
31.86"

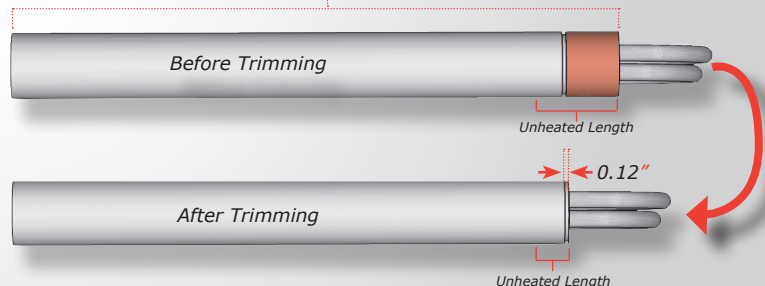

DOUBLE ENDED CONSTRUCTION

- Hotrod cartridge heaters are also available with an electrical termination on each end.
- Heaters can be made with lead wires, straight pins, or screw terminals.



POST TERMINALS

- Post terminals (also called screw terminals or stud terminals) are used in applications where easy lead replacement is desirable. They work great with ring terminals or fork terminals.
- Post terminals are only available for heaters 1/2" diameter and up.
- Terminals are #6-32 and supplied with 2 stainless steel washers and 2 stainless steel nuts on each stud.



BENT CARTRIDGE HEATER

- Cartridge heaters can be bent at any angle from 10° to 120°.
- Heaters must be bent in an unheated section
- Can be constructed with most of the other options shown in this catalog.



Specifications

Heater Diameter	1/4"	5/16"	3/8"	1/2"	5/8"	3/4"	1"
Min. Bend Radius	1/2	1/2	1/2	3/4	1	1-1/4	N.A.
Min. Cold Length	2.25	2.25	2.37	2.87	3.37	3.87	N.A.

END TUBE EXTENSIONS

- Custom Right Angle Tube Extensions are available.
- They serve as an excellent lead support.
- They can also help keep the heater from sliding too far into the hole.
- Please specify dimensions.



SPRING GUARD

- Spring guards are used for additional support in flexing applications.



CIRCUIT OPTIONS

DUAL VOLTAGE

- Dual **Voltage** cartridge heaters can be engineered to operate at different voltage ratings. To order, specify **dual voltage** and **voltage requirements**.

3 PHASE

- Marathon Cartridge Heaters are available for three phase delta for high amperage applications. Certain restrictions apply.

WATTAGE

- We are sometimes asked about DC or frequencies other than 60 Hz. Neither of these affect the performance or wattage rating of the heater.

INDIVIDUALLY CONTROLLED HEAT ZONES

- Individually controlled heat zones give flexibility when needing to control the heat along the length of a cartridge heater. These zones are commonly used in sealing bar applications.
- **Dual Zone** are commonly constructed with 4 power leads.
- **Three Zone** heaters are constructed with (6) color coded leads. Yellow leads indicate disk end zone. Black leads indicate center zone. Red leads indicate lead end zone. Please consult factory for available diameters. Specify length and wattages of desired zones.

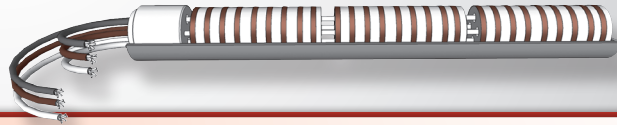

DISTRIBUTED WATTAGE

- Distributed wattage heaters are often used in platens and sealing bars. Wattage is usually increased on the ends of the heater to compensate for end losses and maintain a constant temperature along the heated product.
- Specify desired lengths in inches and wattages in percentage.



TODAY HEATERS

Marathon Heater, Inc. has thousands of standard stock cartridge heaters ready for a variety of modifications.

Stock heaters can ship the same day with the following options:

- Trimmed cavity
 - Rt. Angle Leads
 - Stainless Steel Braid
 - Rt. Angle Stainless Steel Braid
 - Stainless Steel Flexible Conduit
 - Rt. Angle Stainless Steel Flexible Conduit
 - Standard Flanges
 - Brass and Stainless Steel NPT fittings
- Diameters include:**
- 1/4"
 - 3/8"
 - 1/2"
 - 5/8"
 - 3/4"
- All heaters come with either 14", 26", or 38" high temperature leads.
 - Allow 1 extra day for options requiring potting.

The Today Heaters part numbers are also easily available online at www.marathonheater.com.

Orders must be received by 2:00 pm CST in order to ship the same day.

Out of stock heaters and heaters with options such as fittings and potting will ship the next day.

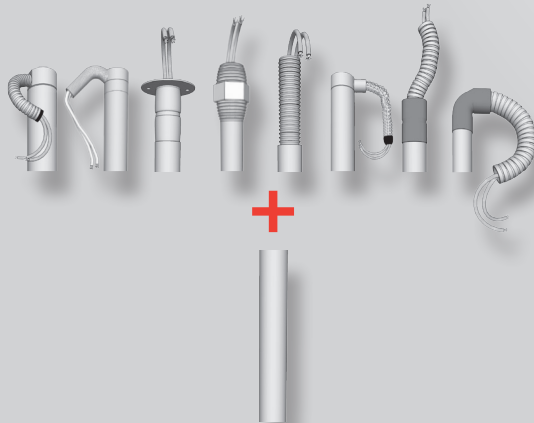
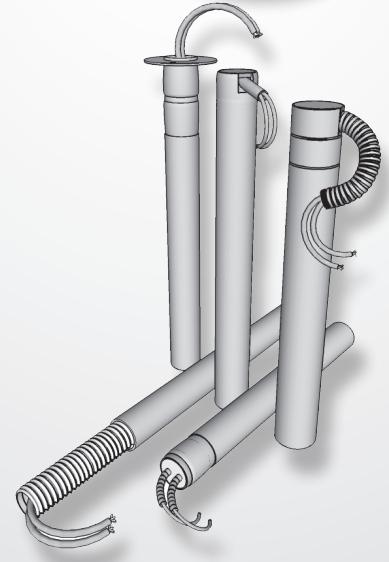

HOW TO ORDER

Step 1: Choose a Today Heater Stock part # that matches your required dimensions and wattage. Get the part #'s at marathonheater.com (xxxxxxxxx)

Step 2: Choose your lead length (in).

Step 3: Choose your option (Conduit, right angle leads, etc.).

Step 4: Choose your lead protection length (in).

OPTIONS CHART

OPTION	CODE
Right Angle Leads	R
Stainless Steel Braid	B
Right Angle St. Steel Braid	A
Flexible Conduit	C
Right Angle Flexible Conduit	K
Standards Brass NPT	H
Oversize Brass NPT	HH
Standard Stainless NPT	Q
Oversize Stainless NPT	QQ
Standard Flange	F
Oversize Flange	FF
Epoxy Potting	E
EpoxyLite Potting	X
Silicone Rubber Potting	V
Cement Potting	P
Convolved Tubing	Y
Right Angle Convolved Tubing	Z
Copper Elbow	W
Copper Coupler	U

NON-SWAGED CARTRIDGE HEATERS

COST-EFFECTIVE NON-SWAGED HEATERS

APPLICATIONS

For applications where a swaged heater is not required, non-swaged cartridge heaters offer a cost effective alternative. Non-swaged heaters can be used up to 45 w/in² and to temperatures up to 800°F. Non-swaged heaters offer tighter length tolerances ($\pm 1/16''$) than swaged heaters. Non-swaged heaters can be built with 3 independent heat zones. Non-swaged heaters are not recommended for applications where there is a lot of vibration or impact.

Most of the lead configurations and options available for swaged HotRod heaters are also available for non-swaged cartridge heaters. Consult your Marathon Heater agent for more information.

- Standard leads are UL rated to 550°C. Leads are connected internally with nickel connectors.
- High temperature cement filling protects leads and internal parts. Epoxy and silicone rubber are also available.
- Nickel-Chromium resistance wire stretched evenly throughout the heated length.
- High purity MgO is vibratory filled into the heater for maximum heat transfer.
- 304 Stainless Steel sheath for superior oxidation resistance.
- Welded end disc to prevent contamination and moisture absorption.

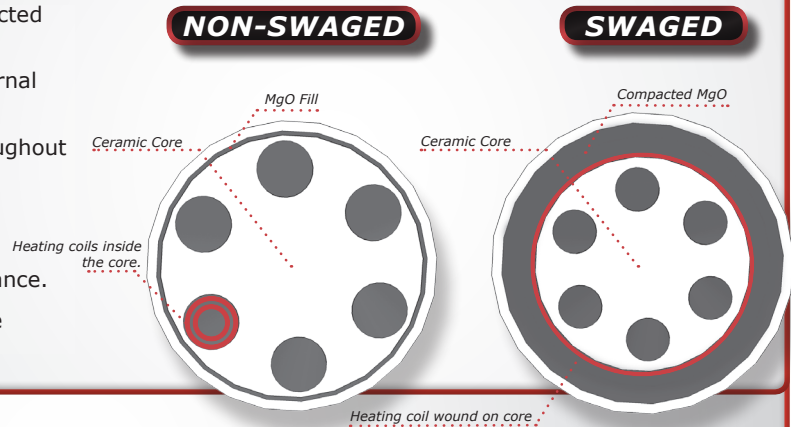

SPECIFICATIONS

Nominal Diameter	Minimum Diameter	Maximum Diameter	Std. Lead Wire Gauge	Max amps with Std. Lead Wire	Max lead wire gauge	Maximum Amps	Maximum Volts
3/8"	.37	.37	22	9	18	15	480
1/2"	.49	.50	22	9	18	15	480
5/8"	.62	.62	18	9	16	25	600
3/4"	.74	.75	18	15	16	20	600
1"	.99	1.0	18	15	16	20	600

Clearance is determined by taking the hole diameter and subtracting the heater diameter.

- Cycling reduces heater life and high cycling applications should use lower numbers.
- Staying below these values will result in increased heater life.

FORMULA

Watt density is calculated with the following formula:

$$\text{Watt Density} = \frac{\text{Wattage}}{\text{Heated Length} \times \text{Diameter} \times 3.14}$$

Hole Clearance	Block temperature in °F				
	1000	800	600	400	200
0.003	25	30	35	40	45
0.005	20	25	30	35	45
0.010	20	23	28	30	38
0.015	18	20	25	27	34
0.030	16	15	20	23	30
0.100	10	12	15	20	25

SQUARE CARTRIDGE HEATERS

HIGH DENSITY SQUARE CARTRIDGE HEATERS

For those applications where a drilled hole is not practical, Marathon Heater offers square cartridge heaters. Unlike square cartridge heaters from other manufacturers, Marathon's square cartridge heaters are swaged, allowing them to be used in high temperature and high watt density applications.

Square heaters are ideal for milled slots in long platens where drilling a long hole would be too difficult. Square heaters are also much easier to remove from a slot after extended high temperature usage than removing a round heater from a drilled hole.

Typical Applications

- Bag Sealing
- Long platens
- Cutting jaws

Available Diameters

- .375" diameter
- .500" diameter
- .625" diameter

Lead Options

- Rt. Angle leads
- S/S braid
- S/S conduit
- Rt. Angle braid
- Rt. Angle conduit

Heater Options

- Thermocouple
- Flanges
- Tab stops
- Weld beads
- Moisture seals
- Distributive wattage

SPECIFICATIONS

	3/8	1/2	5/8
Max Cross Section	0.374	0.499	0.624
Min. Cross Section	0.369	0.494	0.619
Std. Lead Wire	22	22	18
Maximum Amp.	9	9	15
Max Lead Wire	22	18	18
Max amps with	9	15	15
Maximum Volts	300	300	300
Lead Wire Temp	550 °C	550 °C	550 °C

RECOMMENDED MAXIMUM WATT DENSITIES

Clearance (Inches)	Temperature in °F.					
	1200°F	1000°F	800°F	600°F	400°F	200°F
0.002	105	200	225	225	225	225
0.003	90	150	220	225	225	225
0.004	75	130	160	225	225	225
0.005	65	105	150	210	225	225
0.007	50	75	110	150	175	225
0.010	45	65	80	110	150	170
0.015	35	55	70	80	105	120
0.030	30	45	60	65	75	80
0.060	20	30	35	40	45	50
0.100	15	25	30	35	35	35

UNHEATED LENGTH AT LEAD END OF HEATER

Heater Length	.375" Diameter	.500" Diameter	.625" Diameter
Under 3" Long	.25	.30	.38
Over 3" Long	.90	.90	1.00

Base plate with milled square cartridge heater slots.

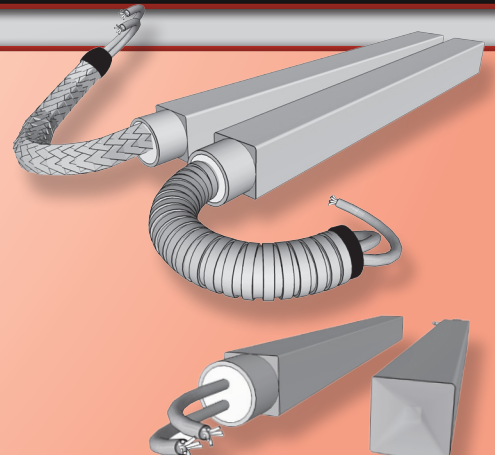
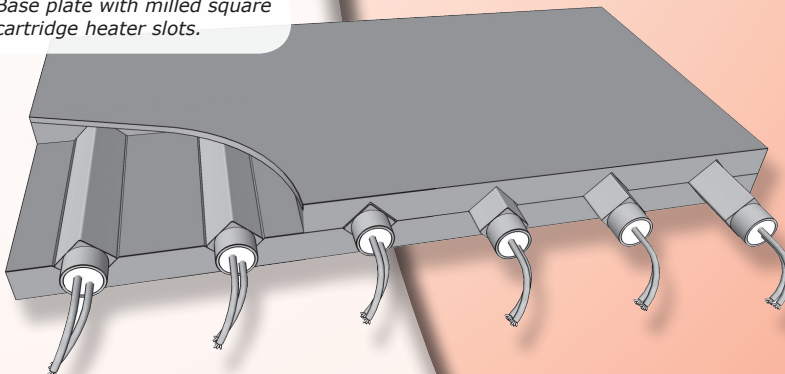

ENGINEERING DATA

MAXIMUM HOTROD WATT DENSITY IN 200°F MOVING AIR

Air Direction	Air Velocity, Feet per Minute								
	0	500	1000	1500	2000	2500	3000	3500	4000
Parallel to Heater	44	52	56	60	64	67	72	75	78
Perpendicular to Heater	44	68	76	82	86	93	97	103	108

MAXIMUM HOTROD WATT DENSITY IN STILL AIR

Max Watts/in ²	Air Temperature °F								
	100	250	500	750	1000	1100	1200	1300	1400
	53	52	50	46	40	35	28	20	13

HOTROD SHEATH TEMPERATURE IN 70°F STILL AIR

	Watt Density (watts/in ²)								
	5	10	15	20	25	30	35	40	
Oxidized Sheath	450	800	1050	1100	1200	1300	1350	1400	
Non-Oxidized Sheath	750	1000	1150	1300	1400	1500	1600	1650	

SHEATH SUITABILITY CHART

- Our standard sheath material, 304 stainless steel, is suitable for most applications. For applications above 1200° F the use of Incoloy is recommended.
- The use of Incoloy below 1200° F will provide no performance improvement, however it will increase cost.
- For many immersion applications, especially tap water, 316 stainless steel is the best choice. Please see the chart below for help in determining the best sheath material for your application.

	304 SS	316 SS	Incoloy	Max Watt Density	Max Temp (°F)
Air to 1500°F	E	E	E		
Air to 1600°F	G	G	E		
Air to 1800°F	NR	NR	G		
Acetic Acid	F	G	F	40	180
Acetone	E	E	E	20	130
Alcohol	F	E	E	25	212
Asphalt	E	E	E	4-10	200-500
Caustic Soda, 10%	E	E	E	100	210
De-greasing Solution	G	E	E	40	275
Electroplating Bath, Cadmium	E	E	E	100	180
Electroplating Bath, Copper	E	E	E	100	180
Ethylene Glycol	F	F	F	30	
Freon	E	E	E	2-5	300
Glycerin	E	E	E	10	500
Kerosene	E	E	E	25-30	
Molasses	E	E	E	5	100
Nitric Acid (30% max)	F	F	NR	20	167
Oil, SAE 30	E	E	E	20	250
Oil, SAE 50	E	E	E	10-15	250
Oil; Vegetable or Mineral	E	E	E	30	400
Paraffin or Wax	E	E	E	16	
Steam @ 300°F	E	E	E	30	300
Steam @ 500°F	E	E	E	25	500
Trichlorethylene	F	F	F	30	150
Water, Distilled	E	E	E	300	212
Water, Tap	F	E	E	300	212

E=Excellent, G=Good, F=Fair, NR=Not Recommended

ORDERING

A correct and complete purchase order saves time and money for yourself and your customer. Here are some ordering tips to save playing phone tag with your customers.

- Always distinguish overall length (OAL) and insertion length.
- Include flange and locating ring locations as measured from the disk end.
- Please provide a sketch for zone profiles or distributive wattage heaters.
- Don't forget to indicate if an internal thermocouple is grounded or ungrounded and its location.
- Please remember to include quote numbers on all your purchase orders.

- Please reference applicable quote numbers on all orders.

VARIATION IN QUANTITY

Order Quantity	Over/Under
1-5	0
6-24	1 pc.
25-49	2 pc.
50-74	3 pc.
75-100	4 pc.
100+	5%

F.A.Q.

1 How long will my heater last?

There is no standard heater life in the industry. The life of your heater is affected by:

- Application
- Application temperature
- Watt density
- Cycling
- Hole fit
- Contamination

2 What is the maximum temperature for my heater?

The sheath material will withstand temperatures of up to 1800 F. See "Sheath Suitability Chart" on page 18.

3 What is maximum watt density allowed?

Maximum watt density is determined by several factors including:

- Whether you are heating air, water, oil, metal. Etc.
- Application temperatures
- Hole fit
- See "Watt density" on page 4.

4 How do you wire a 3 zone heater?

- The red wire is the lead end zone.
- The black wire is the center zone.
- The yellow wire is the disk end zone.

5 How much does a heater expand after energizing?

- Expansion is usually not a factor as the part being heated also expands.

6 How can I extend the life of my heater?

- The number one cause of heater failure is contamination.
- When foreign substances enter the heater and carbonize, this causes arcing and failure inside the heater. If temperature or other circumstances prevent you from using an end seal, avoid substances that could enter the heater at the lead entrance.
- Heat transfer compounds, especially greased based ones, are a common source of contamination.
- Wrapping tape around the lead wires is another common source of contamination as the adhesive melts and runs down into the heater. Remember, any organic or carbon based product has the potential to cause contamination.
- Excessive cycling is the next most common cause of failure. Avoid excessive cycling by properly sizing your heater and not using more wattage than necessary.
- Solid state controllers are also easier on the heaters than simple on-off controllers.

AIR HEATERS



SILICONE RUBBER HEATERS

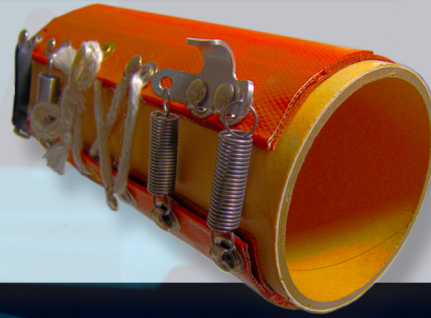

COIL HEATERS



THERMOCOUPLES



MICA BAND HEATERS

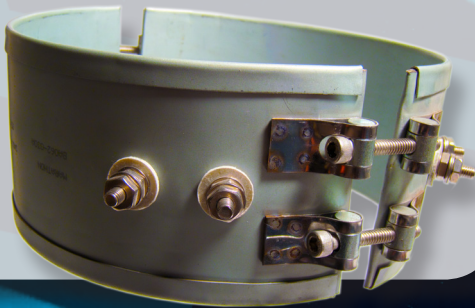

MICA STRIP HEATERS

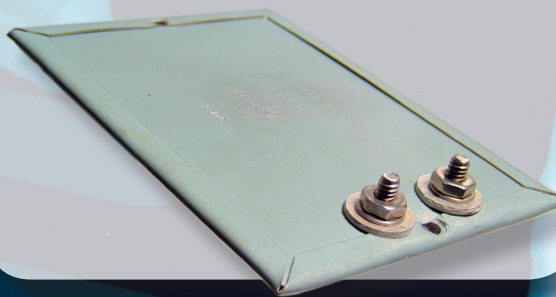

CERAMIC BAND HEATERS



CERAMIC STRIP HEATERS



OTHER PRODUCTS

Your Authorized Marathon Heater Representative is:

Marathon Heater 808 Hackberry Ln., Del Rio, TX, 78840. **Phone:** (830)-775-1417 **FAX:** (830)-775-4379

www.marathonheater.com sales@marathonheater.com

Download our latest brochures at <http://www.marathonheater.com>

©2011 Marathon Heater Inc. All Rights Reserved.

BR-CH-01-11

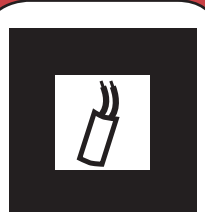

AR Marker

QR Code