

A Pyromation MgO thermocouple assembly consists of a thermocouple element swaged in hard-packed, standard-purity (96%) Magnesium Oxide mineral insulation and encased in a metal sheath. Thermocouple sheaths have been fully annealed; they can be formed into many configurations, and can be bent into a radius of twice the size of its outer sheath. The tables found on this page and the following pages allow customer selection of standard thermocouple types, sheath diameters, mounting fittings and terminations. Custom built products are available upon request.

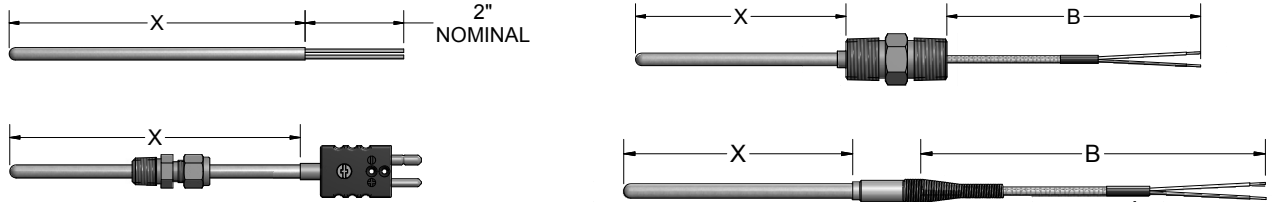

ORDER CODES

Example Order Number:

1-1 1-2 1-3 1-4 1-4 A 1-5
K 4 8 G M - 012 - For Optional Sheath Mounting Fittings See Page MgO-2

1-1 Thermocouple Types

CODE		
SINGLE	DUPLEX	TRIPLEX
E	EE	-
J	JJ	JJJ
K	KK	KKK
T	TT	-
N	NN	-

1-2 Sheath Diameters

CODE	DIAMETER (inches)
1	1/16 ^[1]
2	1/8
3	3/16
4	1/4
6	3/8

[1] 1/16" will be coiled unless otherwise specified for 36" and longer lengths.

1-3 Sheath Materials

CODE	MATERIAL	STANDARD AVAILABLE TYPES
3	Alloy 600	K, N
4	310 Stainless steel	K
5	446 Stainless steel	K ^[1]
8	316 Stainless steel	E, J, K, T

[1] All sensors with 446SS sheaths must have an ungrounded measuring junction.

1-5 "X" Dimension

Insert three digit sheath length ("X" Dimension) in inches
 Sheath lengths over 72" will be shipped in a coiled configuration unless otherwise specified.

1-4 A Special Options

CODE	DESCRIPTION
M	Special limits of error
H	High-Purity MgO Insulation (99.4% Pure)

Use this table only if options are desired.

1-4 Measuring Junctions

CODE	DESCRIPTION
G	Grounded junction
U	Ungrounded junction
E ^[1]	Exposed junction
S	Exposed shielded junction

[1] Not available with 1/16" O.D..

1-2 A Reduced-Tip MgO Thermocouples

CODE	NORMAL SHEATH DIA. O.D. (inches)	TIP DIA. (inches)	TIP LENGTH (inches)	MATERIAL
88R48	1/2	1/4	1 (1/4)	316 SS
68R38	3/8	3/16	1 (1/4)	316 SS
48R28	1/4	1/8	1 (1/4)	316 SS

Table 1-2 A lists thermocouple elements with reduced-tip sheaths. To order, use order code numbers from Tbl. 1-2 A in place of straight sheath order code numbers from Tbl. 1-2 and 1-3. EXAMPLE: J88R48

Select Sheath Mounting or Bend Options as desired from tables below.

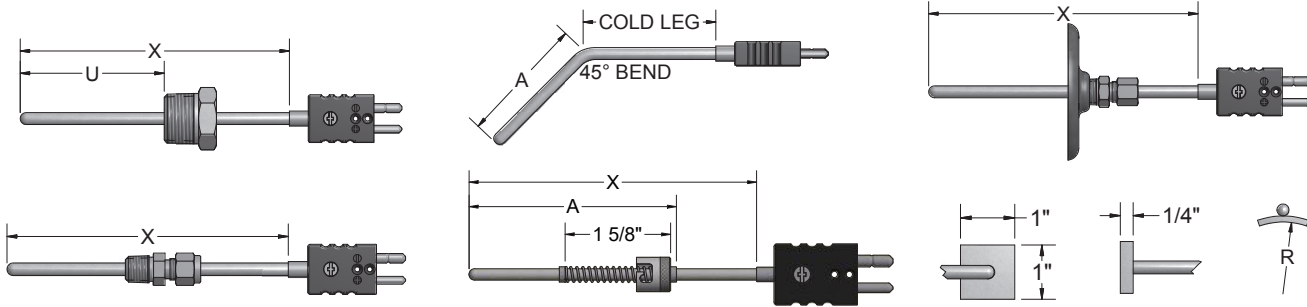

ORDER CODES

2

Example Order Number: **K48GM - 012 - 05A,306** - Page MgO-3 - Page MgO-4 - Page MgO-5

2-1 No Fitting or Bend Options

CODE	00
------	----

2-2 One-Time Adjustable Compression Fittings

CODE	TYPE	NPT SIZE (inches)	PRESSURE RATED	AVAILABLE SHEATH DIAMETERS (inches)
05A	316 Stainless steel	1/8	YES	1/16, 1/8, 3/16, 1/4
05B	316 Stainless steel	1/4	YES	1/8, 3/16, 1/4, 3/8
05C	316 Stainless steel	1/2	YES	1/8, 3/16, 1/4, 3/8
15A	Brass	1/8	NO	1/8, 3/16, 1/4
15B	Brass	1/4	NO	3/16, 1/4, 3/8
15C	Brass	1/2	NO	1/4, 3/8

2-3 Re-Adjustable Compression Fittings

CODE	TYPE	NPT SIZE (inches)	AVAILABLE SHEATH DIAMETERS (inches)
12A	316 Stainless steel	1/8	1/16, 1/8, 3/16, 1/4
12B	316 Stainless steel	1/4	1/8, 3/16, 1/4, 3/8
12C	316 Stainless steel	1/2	1/8, 3/16, 1/4, 3/8
11A	Brass	1/8	1/16, 1/8, 3/16, 1/4
11B	Brass	1/4	1/8, 3/16, 1/4, 3/8
11C	Brass	1/2	1/4, 3/8
19C	Spring-loaded SS well fitting	1/2	3/16, 1/4

FEP gland standard 204 °C [400 °F] max. For lava gland 649 °C [1200 °F] max. opt. 12A, 12B, and 12C only use letter suffix "L" after compression fitting order code. EXAMPLE: 12AL for lava gland.

2-4 Fixed Bushings

CODE	MOUNTING THREAD NPT (inches)	AVAILABLE SHEATH DIAMETERS (inches)
316 SS		
8A __ [1]	1/8	1/16, 1/8, 3/16, 1/4
8B __ [1]	1/4	1/16, 1/8, 3/16, 1/4, 3/8
8C __ [1]	1/2	1/8, 3/16, 1/4, 3/8
8D __ [1]	3/4	1/8, 3/16, 1/4, 3/8

[1] When ordering fixed bushings, specify order code above plus insert length "U", as measured from hot tip to bottom of threaded bushing. EXAMPLE: order code 8A06 is 1/8" NPT, 316 SS bushing located 6" from hot tip.

2-5 Sheath Bends

CODE	DESCRIPTION
2 __	Sheath bent 45°
3 __	Sheath bent 90°

When ordering bend options, specify hot leg dim. "A". EX: order code 206 is a 45° bend with 6" hot leg. Total sheath length in Table 1, referred to as "X" length = hot leg plus cold leg.

2-6 Weld Pads

CODE	DESCRIPTION
17	316 SS weld pad 1" x 1" x 1/4" thick perpendicular mount
18	316 SS weld pad 1" x 1" x 1/4" thick horizontal mount
17R	316 SS weld pad 1" x 1" x 1/8" thick perpendicular mount with radius bend (specify radius)
18R	316 SS weld pad 1" x 1" x 1/8" thick horizontal mount with radius bend (specify radius)

2-7 Miscellaneous Options

CODE	DESCRIPTION	AVAILABLE SHEATH DIAMETERS (inches)
13A __ [1]	Spring-loaded bayonet fitting	1/8, 3/16
14	Adjustable flange with brass compression fitting	1/8, 3/16, 1/4, 3/8
16A	Compression fitting with bayonet cap and spring	1/8 (2 5/8" min. "A" dim.)

[1] When ordering fixed bayonet fitting, specify hot leg dimension "A". EXAMPLE: order code 13A06 for a fixed bayonet adapter with 6" hot leg. Total sheath length is Table 1 "X" length = hot leg plus cold leg.

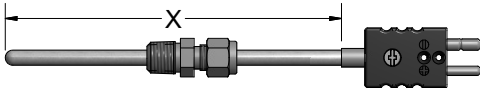
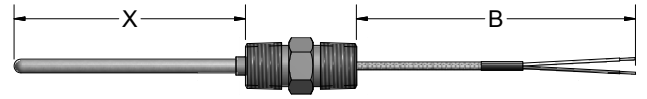

Mg02

ORDER CODES

Mg01

Example Order Number: **K48GM - 012 - 15C - 4, MC** or **K48GM - 012 - 00 - 16** - Page MgO-4 - Page MgO-5

3-1 Plug and Jack Sheath Terminations

CODE	DESCRIPTION
4	Standard plug
5	Standard jack
6 ^[1]	Miniature plug
7 ^[1]	Miniature jack
Options	
MC	Mating connector
HT	High temp connector 350 °C [662 °F]
SP ^[2]	Solid pin plug
CL ^[3]	Compression L bracket to hold plug to sheath
[1] Not available with 1/4 or 3/8" O.D. sheath. [2] Standard with 350 °C [662 °F] [3] Not available with miniature connector and must be selected with HT option	

3-1 Sheath Terminations

CODE	DESCRIPTION
10	2" stripped leads (insert two digit strip length for other lengths - ex. 10(03"))
[1] Only available on 1/8, 3/16, 1/4" O.D. sheath.	

3-2 Leadwire Transitions

(Requires Table 4 and 5 selections)

CODE	DESCRIPTION
15	Extension leadwire transition with relief spring 204 °C [400 °F]
16	Extension leadwire transition with heat-shrink tubing 104 °C [220 °F]
13 ^[1]	Same size transition with heat-shrink tubing 104 °C [220 °F]
18 ^[1]	Same size transition without heat-shrink tubing 204 °C [400 °F]
19	Extension leadwire transition w/o spring or heat-shrink tubing 204 °C [400 °F]
Options	
HT ^[2]	High-temperature potting 538 °C [1000 °F]
[1] Not available with Flex Armor [2] Not available with option 13 or 16. When specifying high temp potting with Flex Armor, Option 19 must be selected.	

3-2 Threaded Fittings with Extension Leadwire

(Requires Table 4 and 5 selections)

CODE	DESCRIPTION
6HN23	1/2" x 1/2" NPT steel hex nipple
8HN23	1/2" x 1/2" NPT stainless steel hex nipple
9HP23	1/2" NPT stainless steel bushing (no process threads)
8RND23	3/4" process x 1/2" NPT stainless steel hex nipple

Select desired leadwire type by order code number, followed by desired length in inches

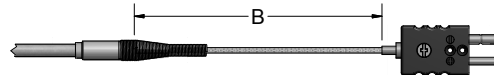
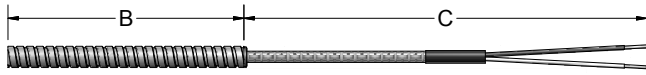

ORDER CODES

Example Order Number:

K48GM - 012 - 05A,306 - 15 -

F1048

Page
MgO-5

4

	CODE	DESCRIPTION	AVAILABLE CALIBRATIONS					TEMP. RATING
			J	K	T	E	N	
Fiberglass	F1	Fiberglass insulation - solid conductor	J	K	T	E	N	482 °C [900 °F]
	F1A	Fiberglass insulation - solid conductor - flexible armor	J	K	T	E	N	482 °C [900 °F]
	F1B	Fiberglass insulation - solid conductor - stainless steel overbraid	J	K	T	E		482 °C [900 °F]
	F3	Fiberglass insulation - stranded conductor	J	K	T	E		482 °C [900 °F]
	F3A	Fiberglass insulation - stranded conductor - flexible armor	J	K	T	E		482 °C [900 °F]
	F3B	Fiberglass insulation - stranded conductor - stainless steel overbraid	J	K	T			482 °C [900 °F]
	H1	Hi-temp fiberglass insulation - solid conductor	J	K				704 °C [1300 °F]
	H1A	Hi-temp fiberglass insulation - solid conductor - flexible armor	J	K				704 °C [1300 °F]
	H1B	Hi-temp fiberglass insulation - solid conductor - stainless steel overbraid	J	K				704 °C [1300 °F]
Fluoropolymer	T3J	Individual stranded fluoropolymer leads - 12 inch limit	J	K				204 °C [400 °F]
	T1	Fluoropolymer insulation - solid conductor	J	K	T		N	204 °C [400 °F]
	T1A	Fluoropolymer insulation - solid conductor - flexible armor	J	K	T		N	204 °C [400 °F]
	T1B	Fluoropolymer insulation - solid conductor - stainless steel overbraid	J	K				204 °C [400 °F]
	T1M	Fluoropolymer insulation - solid conductor - polyester shield	J	K				204 °C [400 °F]
	T3	Fluoropolymer insulation - stranded conductor	J	K	T	E		204 °C [400 °F]
	T3A	Fluoropolymer insulation - stranded conductor - flexible armor	J	K	T	E		204 °C [400 °F]
T3B	Fluoropolymer insulation - stranded conductor - stainless steel overbraid	J	K				204 °C [400 °F]	
PVC	P5	PVC insulation - solid conductor	J	K	T	E	N	105 °C [221 °F]
	P7	PVC insulation - stranded conductor	J	K				105 °C [221 °F]
	P5M	PVC insulation - solid conductor - polyester shield	J	K	T			105 °C [221 °F]
	P7M	PVC insulation - stranded conductor - polyester shield	J	K				105 °C [221 °F]
	C3060	PVC insulated coil cord - stranded; 60" extended	J	K	T	E		105 °C [221 °F]
	C3120	PVC insulated coil cord - stranded; 120" extended	J	K	T			105 °C [221 °F]
Polyimide	K1	Polyimide insulation - solid conductor	J	K				316 °C [600 °F]
	K1A	Polyimide insulation - solid conductor - flexible armor	J	K				316 °C [600 °F]
	K3	Polyimide insulation - stranded conductor	J	K				316 °C [600 °F]
	K3A	Polyimide insulation - stranded conductor - flexible armor	J	K				316 °C [600 °F]

Insert wire code number and 3 digit "B" length code. **Example: F1036 = 36" "B" length.**

For assemblies requiring leadwire beyond the flexible armor, illustrated as "C" in drawing, insert 3 digit "C" length after armor length. **Example: T1A036-012 = 36" "B" length with additional 12" "C" length leads beyond armor.**

Insulated leadwires in flexible armor are available with either extruded PVC or FEP covering over the flexible armor. Substitute suffix codes T (FEP) or P (PVC) for the suffix "A" code above. **Example: T3T is FEP covered armor.**

Duplex elements supplied with individual leads.



Select desired leadwire termination and options (if desired) by order code numbers below

OPTIONS 4 OR 4,MC

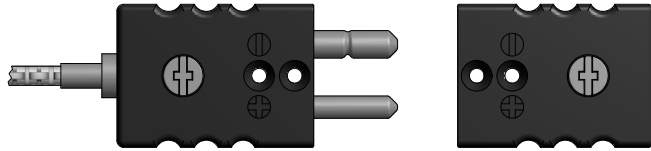

OPTIONS 6 OR 6,MC

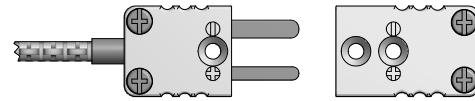

OPTION 3



OPTION 8



ORDER CODES

Example Order Number: **K48GM - 012 - 05A,306 - 15 - F1048 -** 5-1
4, 5-2
CC

5-1 Terminations

CODE	DESCRIPTION
0	Leads not stripped
2	2" split leads, 1/4" stripped
3	2" split leads with spade lugs
4	Standard plug
5	Standard jack
6	Miniature plug
7	Miniature jack
8	2" split leads with 1/4" quick disconnect female terminal lugs

5-2 Options

CODE	DESCRIPTION
BX	1/2" NPT BX connector with Opt. 0, 2, 3, or 8
CC	Plug or jack secured to leads with cable clamp
RB	Rubber boot
SP ^[1]	Solid pin plug
CG	Cord grip (1/2" Nylon)
MC	Mating connector
HT	High temp. connector 350 °C [662 °F]
[1] Standard with 350 °C [662 °F]	