

CAN Gateway Features :

- DIN Rail or Panel Mounted compact Protocol Converter
- Hardware with two communication ports
COM1 : RS232 / RS422 / 2 or 4 wire RS485 / CMOS and
COM2 : CAN(J1939/CANopen Slave)
- Two devices, one with serial communication port and the other with CAN communication port can be connected
- Connect your Serial Device (PLCs, Drives, Controllers etc.) on CAN BUS
- Same model can be re-configured for connecting different PLCs / devices on Serial Port
- Low power consumption of only 2.5 Watts
- Common Programming software for the entire Gateway family.....FREE!!
- CE with UL certification

Possible Applications :

GWY-300 connects one field device (serial link) to another over CAN BUS. User can define the blocks of registers to be fetched from one device and to be transferred to the other. Our users have used Gateway units in different applications across many industries. The typical configuration includes the following:

Data Exchange between PLC and Engine Control Unit (J1939 application)

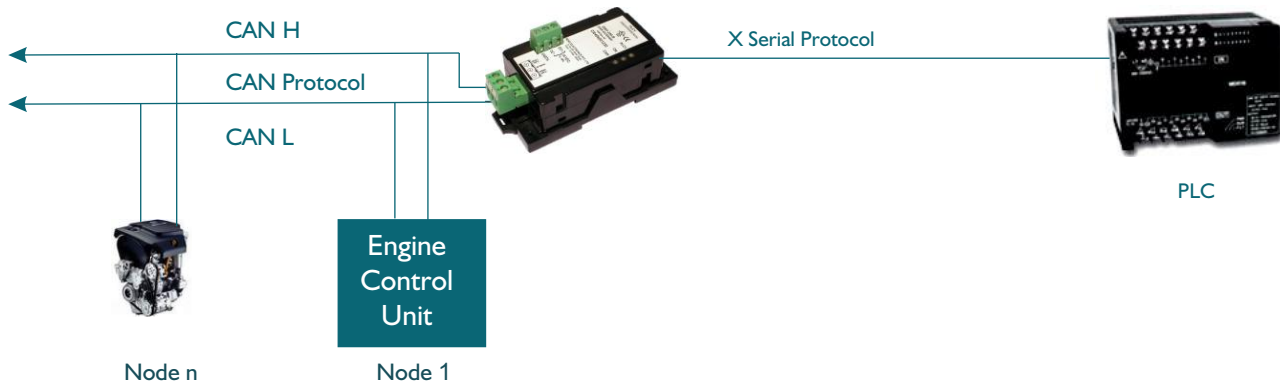

Data Exchange between CANopen Master and Slave (CANopen application)

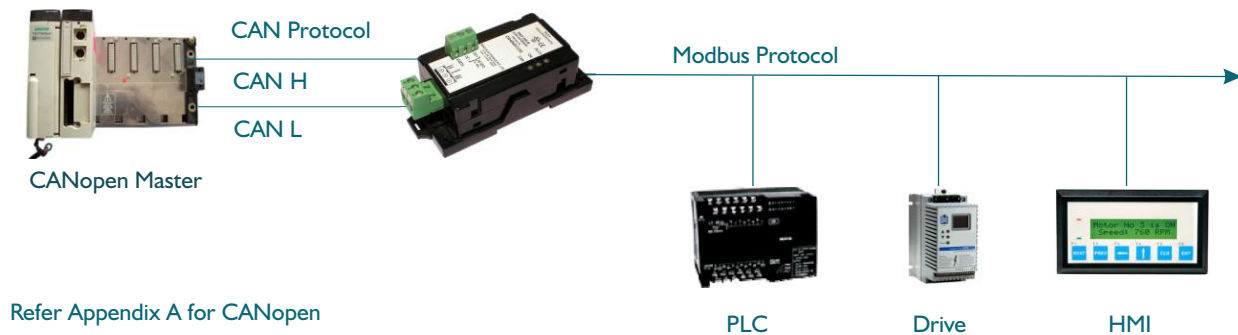

Refer Appendix A for CANopen

Modbus Slaves

* Images not to scale.

GWY-300 Operations :

GWY-300 is a Protocol Converter / Data sharer for devices like PLCs, Inverters, Controllers etc. GWY-300 has a serial port that connects to a serial device and a CAN port which connects to CAN BUS. GWY-300 communicates with a device to get the information required by the other device.

Our Windows[®] based Gateway setup software makes it easy to configure the protocol converter. After choosing which protocol to use for each port, user can program the Gateway to transfer the data blocks. Using a simple spreadsheet format, user can simply program the Gateway to fetch a specified number of registers or bits from one device and transfer them to the other. Powerful software allows user to transfer all the information continuously or allows the PLC to control the transfer of data from selected blocks.

System requirements for Gateway Setup Software are:

Windows Version	: Microsoft Windows XP / 2000, Windows 7 / VISTA
Processor	: PENTIUM or higher
Hard disk Space	: 5 MB or more
RAM	: 64 MB or more
Display resolution	: 800 X 600 (VGA) or better
Display colors	: 16 bit color

Programming software is common for the entire Gateway family.

Other Accessories required for the GWY-300 configuration and to use in actual application:

1. Gateway Configuration / Connecting Cable.**
2. Gateway Setup Software .
3. Devices with communication cables.

** Refer our website (www.renuelectronics.com) for your specific Cable requirements

Communication Ports :

GWY-300 has two communication ports COM1 and COM2. COM1 port is compatible to RS232 / RS422 / RS485 and the other is a CAN communication port (COM2). The Pin-outs of these ports are as shown below:

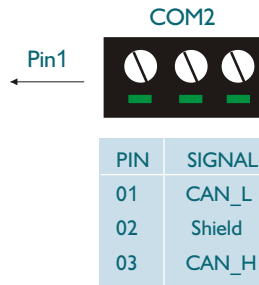
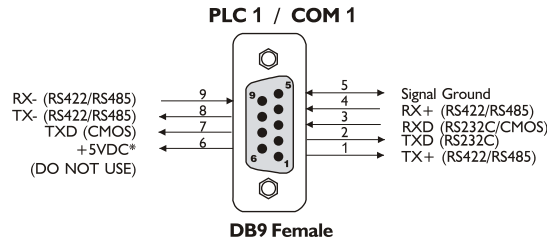

* Do not use pin no. 6 of the GWY-300 communication port.

Protocols supported for :

The GWY-300 currently supports CAN-J1939 and CANopen application layer protocols on CAN BUS Port.

It supports following devices :

- ABB (Modbus RTU)
- Delta DVP Series (Modbus RTU)
- IDEC Micro3 / C, IDEC MicroSmart, IDEC Open Net
- Messung NEXGEN 2000 / NEXGEN 4000 / NEXGEN 5000 (Modbus RTU)
- Modbus RTU (Master)
- Omron Host Link
- Telemecanique 17, 47 & 67 Series
- Toshiba T1, T2, T3 (Link Port)
- Xtra Drive PLCs on COM1 side
- AB DF1 Full Duplex (Micrologix /SLC5/0x / PLC5/30)
- GE Fanuc Series 90-30, VersaMax
- Modbus RTU (Slave)
- Siemens-S7-200 PPI
- Toshiba ASD
- Twido (Modbus RTU)
- Yaskawa Drives

It can also support following Devices on request:

- AB DH485 (SLC5 / 0x series)
- Baldor Drives
- Idec Micro 1 / FA2jr PLCs
- Koyo
- Messung XMP-8
- Taian TP02 Series
- USS Protocol
- Aromat FP0 / FP1 / FP2 / FP Sigma and FPM
- Crouzet
- Keyence KV
- LG MasterK 80S-300S
- Mitsubishi FX
- Toshiba T series (Programming Port)

GWY-300 can communicate with all the above Devices using different communication cables.

For detailed information on Gateway, visit our Website: www.renuelectronics.com or contact factory.

New Device drivers are constantly added. Please contact factory for more information.

We welcome an opportunity to develop new, custom drivers and customization of Gateway products.

Specifications :

Power	:	+24V DC \pm 10%, 100mA max
LEDs	:	3 LEDs for status indication
Communication Ports	:	2 Communication ports with
PLC1 / COM1	:	RS232 / RS422 / RS485 / CMOS
PLC2 / COM2	:	CAN-J1939/CANopen Slave (Isolation between communication ports and Power supply, through DC-DC coupler is 1 KV)
PLC1 / COM1	:	Connects to PC for application download or connects to PLC1 at runtime.
PLC2 / COM2	:	Connects to CAN BUS. (Isolation between communication ports, through opto-isolation, is 1KV rms for 1 min)
Temperature	:	Operating : 0° to +60° C Storage : -20° to +80° C
Humidity	:	10% to 90% (Non condensing)
Mounting	:	DIN rail or back panel mounting
Dimensions (DIN rail)	:	105mm(L) X 40mm(D) X 51mm(W)
Weight	:	125 gm approx.
Certifications	:	CE with UL
Immunity to ESD	:	as per IEC61000-4-2
Immunity to Fast Transients	:	as per IEC61000-4-4
Immunity to Radiated electromagnetic field	:	as per IEC61000-4-3
Immunity to Conducted disturbances	:	as per IEC61000-4-6
Surge	:	as per IEC61000-4-5
Radiated emission	:	as per EN61000-6-4

Models :

Series/Model	Technology	Protocol
GWY-00	Serial	Various
GWY-100	LonWorks	LonTalk
GWY-300	CANBUS	CAN (J1939/CANopen)
GWY-500	Profibus	Profibus-DP-V0
GWY-610	Ethernet	Modbus TCP/IP
GWY-800	HART	HART
GWY-900	GSM	Various

Dimensions :

GWY-300 unit is shipped with a separate DIN rail plate which can be attached to the unit, if desired. User can use the unit with or without the DIN rail plate. Following sketch shows dimensional details of Gateway with the DIN rail plate.

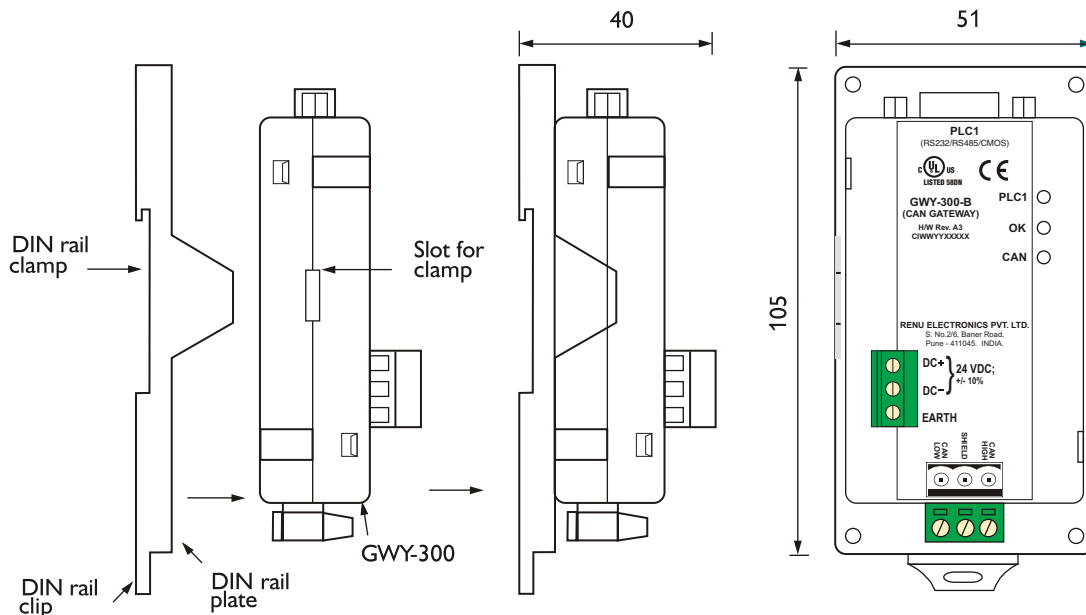

All dimensions are in mm.

Appendix A - CANopen Slave Specifications

1. 11 bit identifier
2. Software selectable Baud rate upto 1Mbps
3. Software selectable node ID
4. DS301 V4.02 compliant
5. Support for the NMT object
6. One Server SDO service.
7. 4 Sets of dynamically mapped PDO
8. Support for Heart Beat and Node-Guarding both
9. Support for EMCY message and the SYNC objects.
10. The Input / Output area divided into Byte / Word / Double word access like a DPRAM access.
11. EDS File

The manufacturer specific area shall be again divided into Input / Output Byte / Word / Double Word range.

Table for index support:

Index	Sub Index	Parameter	Type
2000-2001	00 to FF	Input Buffer, Byte Access	U8
2100-2101	00 to FF	Input Buffer, Word Access	U16
2200	00 to FF	Input Buffer, Dword Access	U32
2400-2401	00 to FF	Output Buffer, Byte Access	U8
2500-2501	00 to FF	Output Buffer, Word Access	U16
2600	00 to FF	Output Buffer, Dword Access	U32

These indices are extendable on request

CANopen Slave Gateway Applications :

1. PLC to PLC Communication

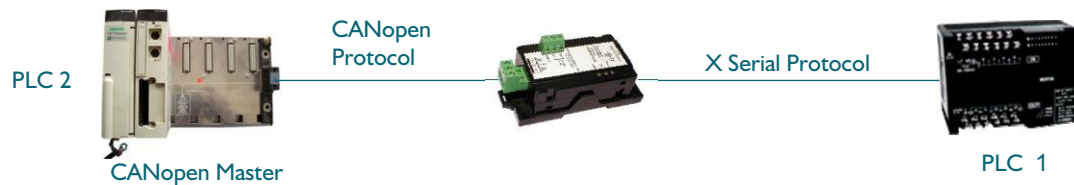

2. HMI as a CANopen Slave

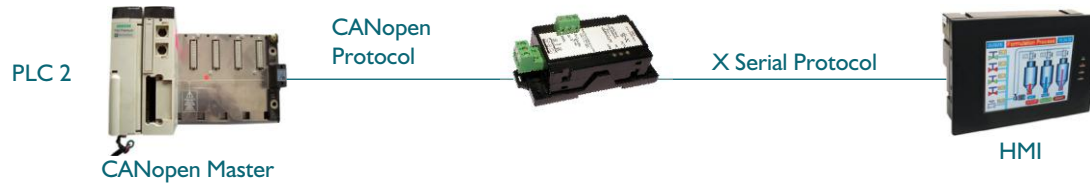

3. Drive as slave in CANopen network

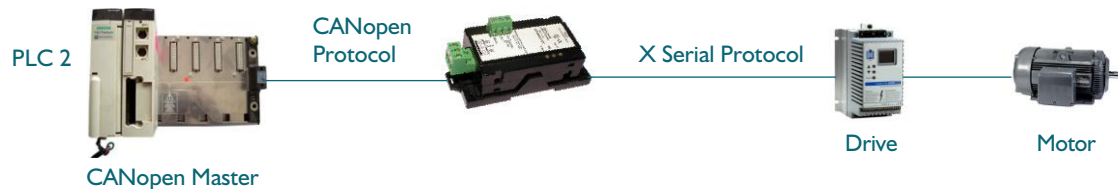

4. Add I/O to your PLC

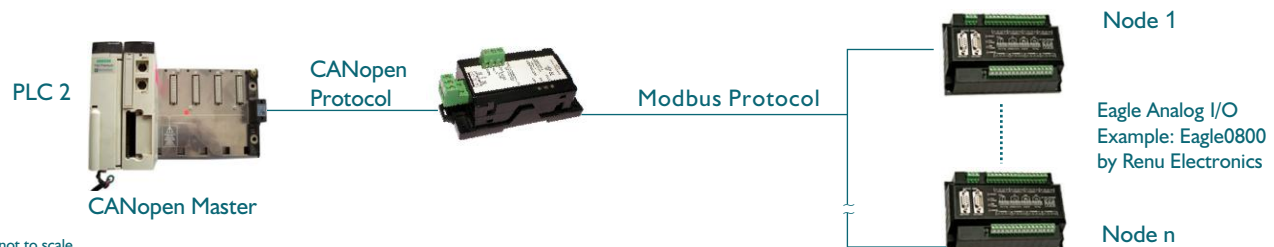

* Images not to scale.



FACTORY

Survey No. 2/6, Baner Road, Pune - 411045, India.
 Tel : +91 20 2729 2840 Fax : +91 20 2729 2839
 Email : info@renuelectronics.com
 Website: www.renuelectronics.com

An ISO 9001 : 2008 and ISO 14001 : 2004 certified company